

Fruit catapult

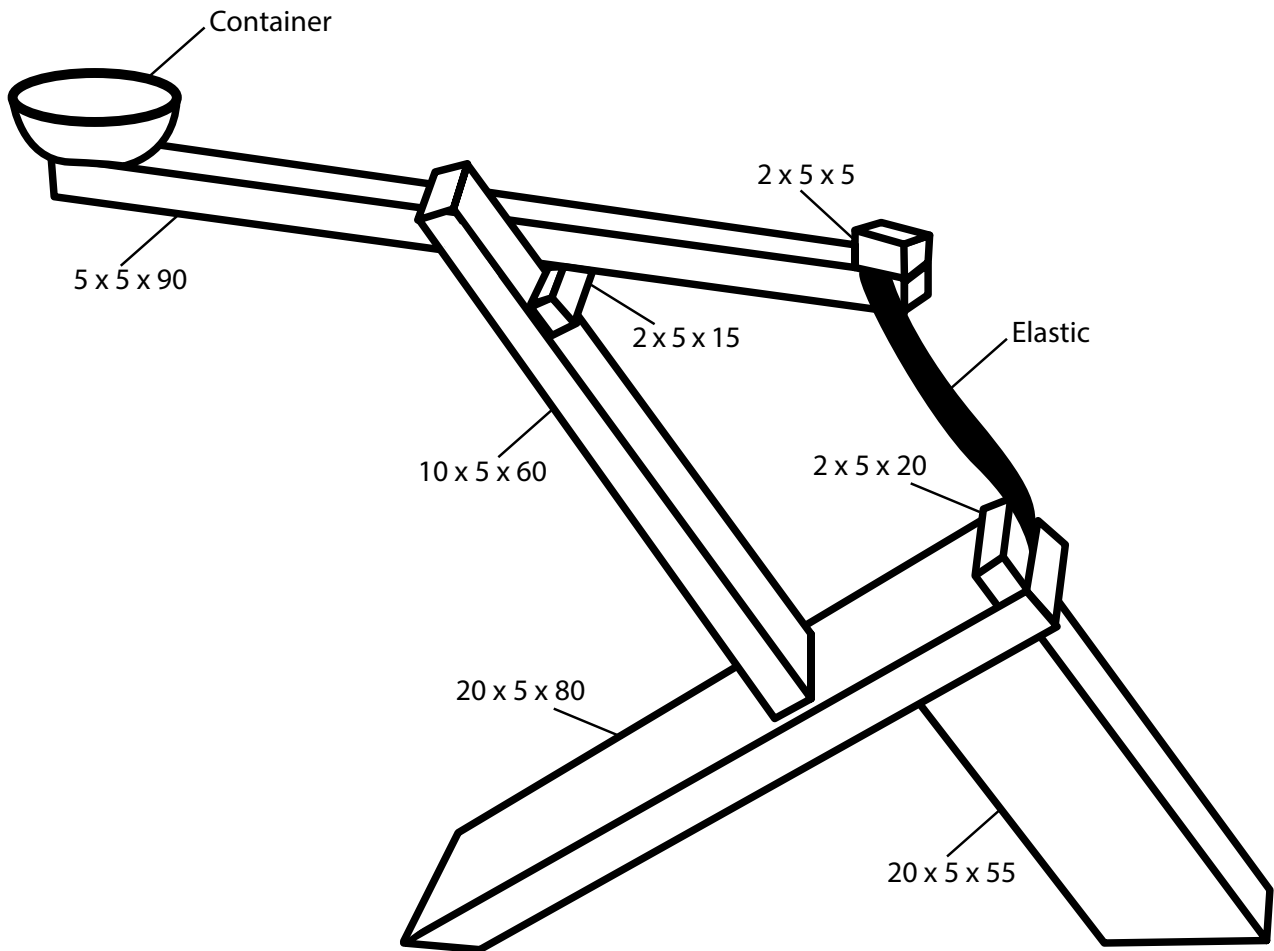

Clothes peg catapults

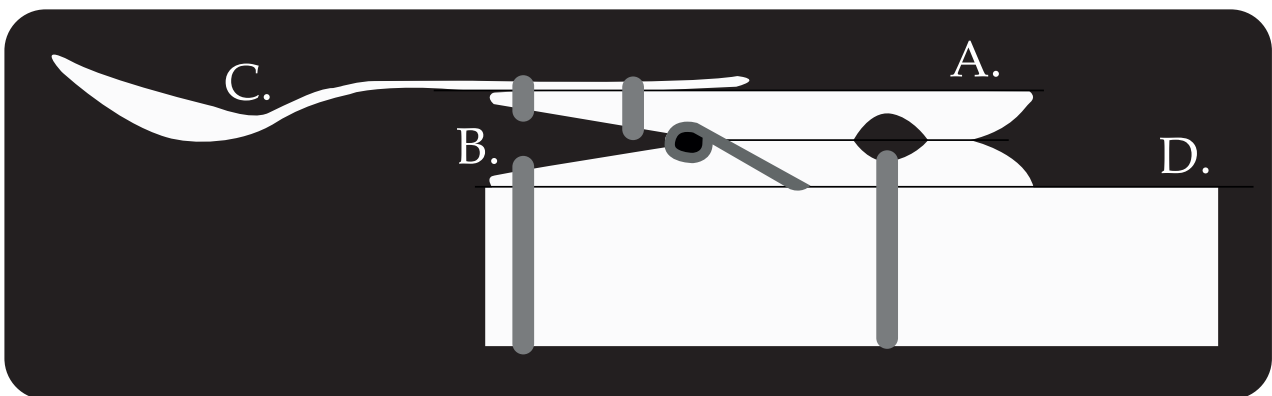

Key

- A. Clothes peg
- B. Elastic band
- C. Plastic spoon
- D. Wooden block

Wooden boats

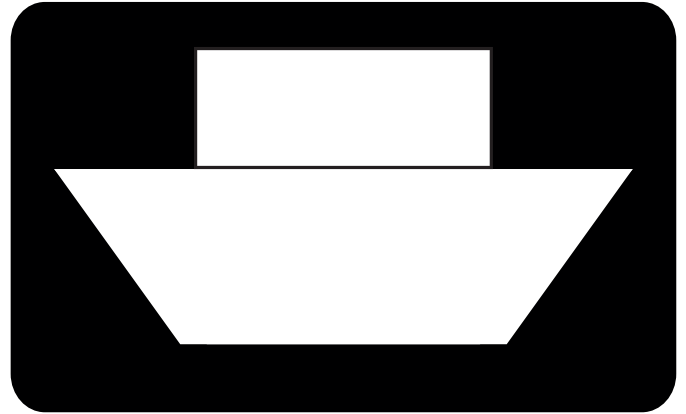
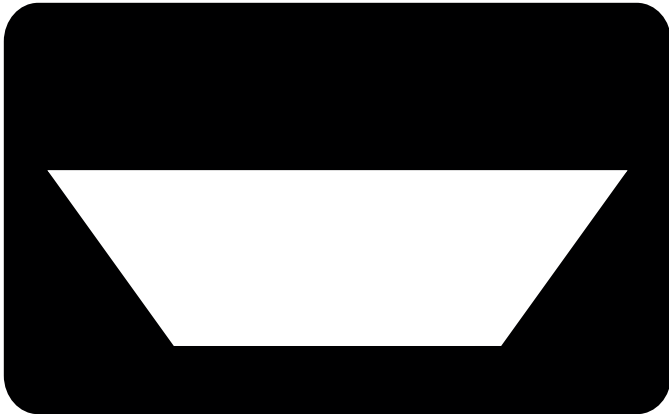
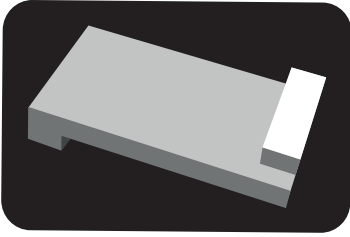

Exploding lollipop sticks

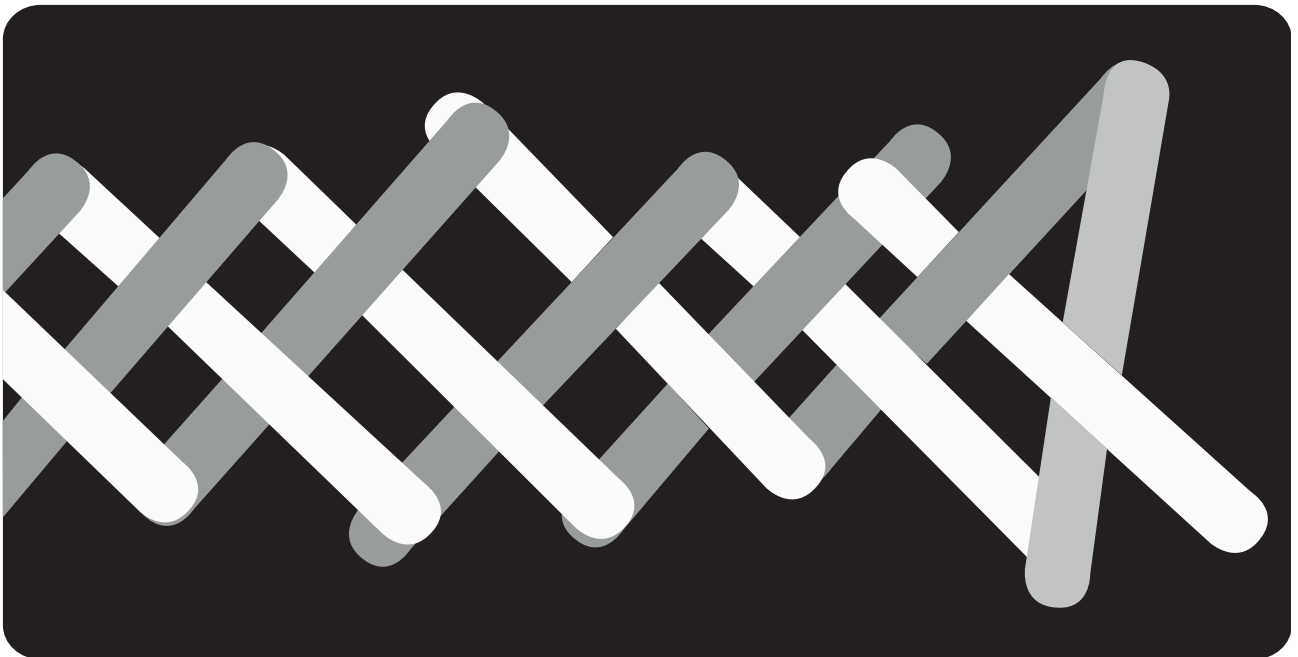

Mobius strips

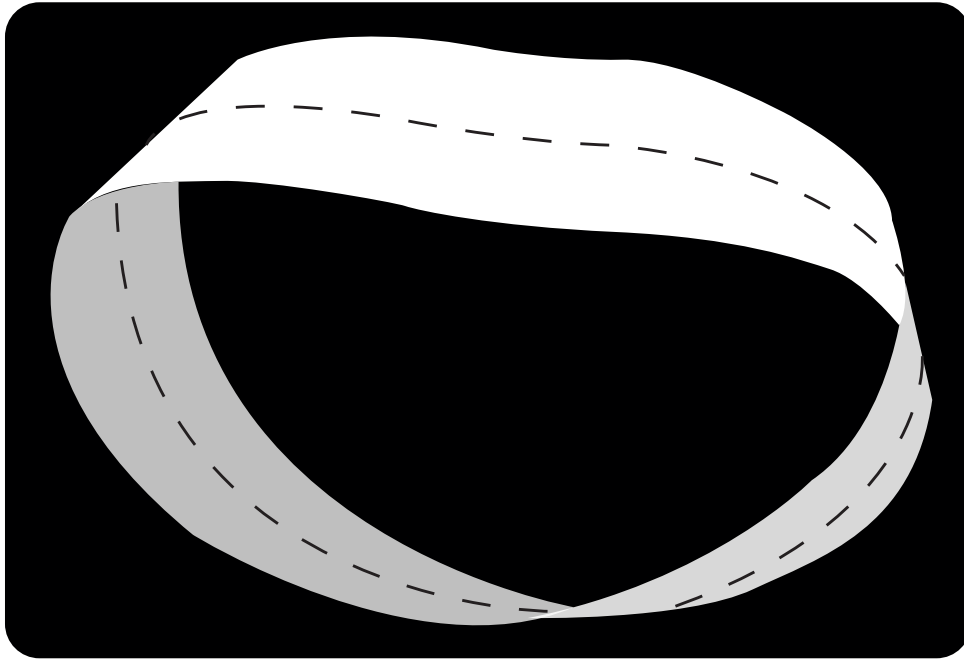

3D pictures

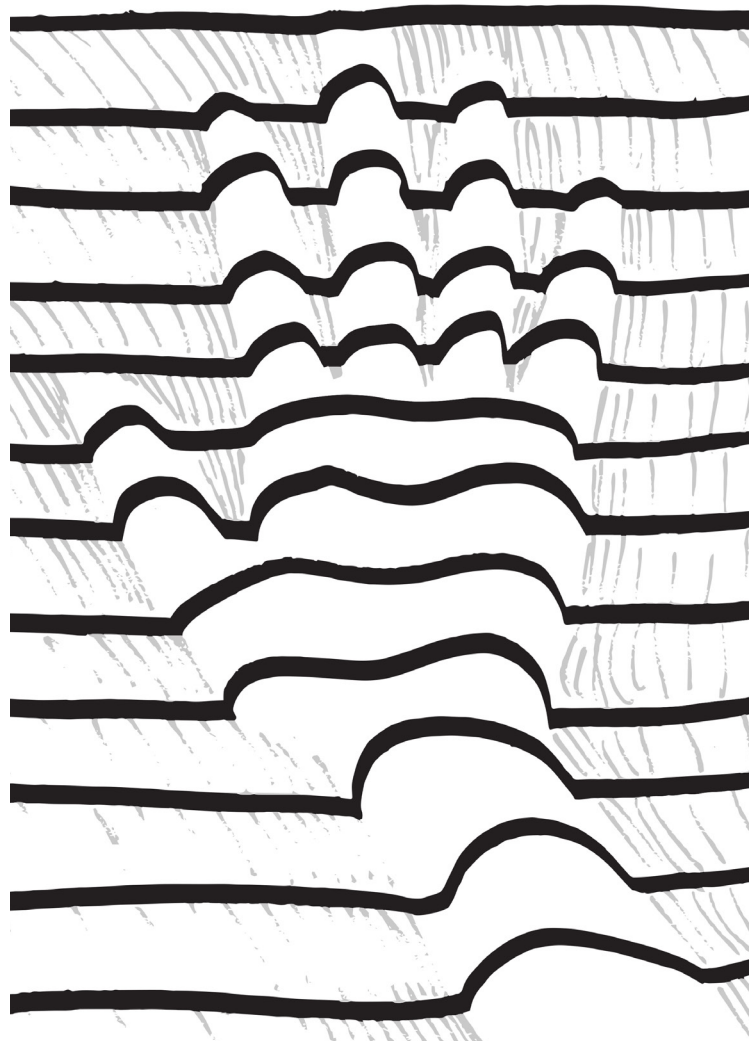

Friendship bracelets

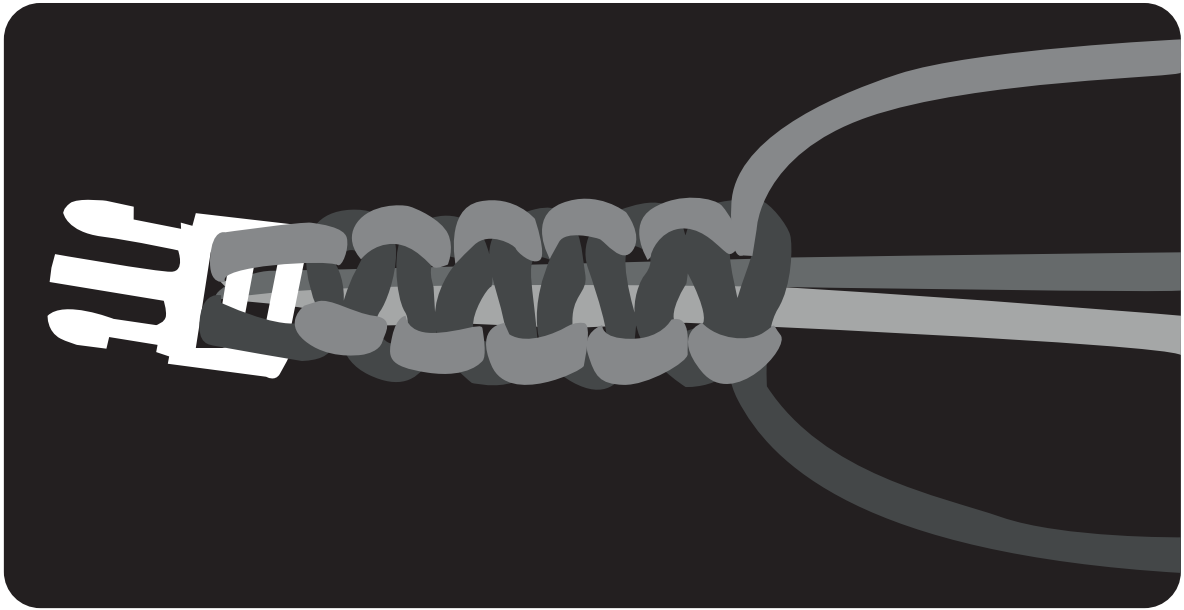

Shadow puppets

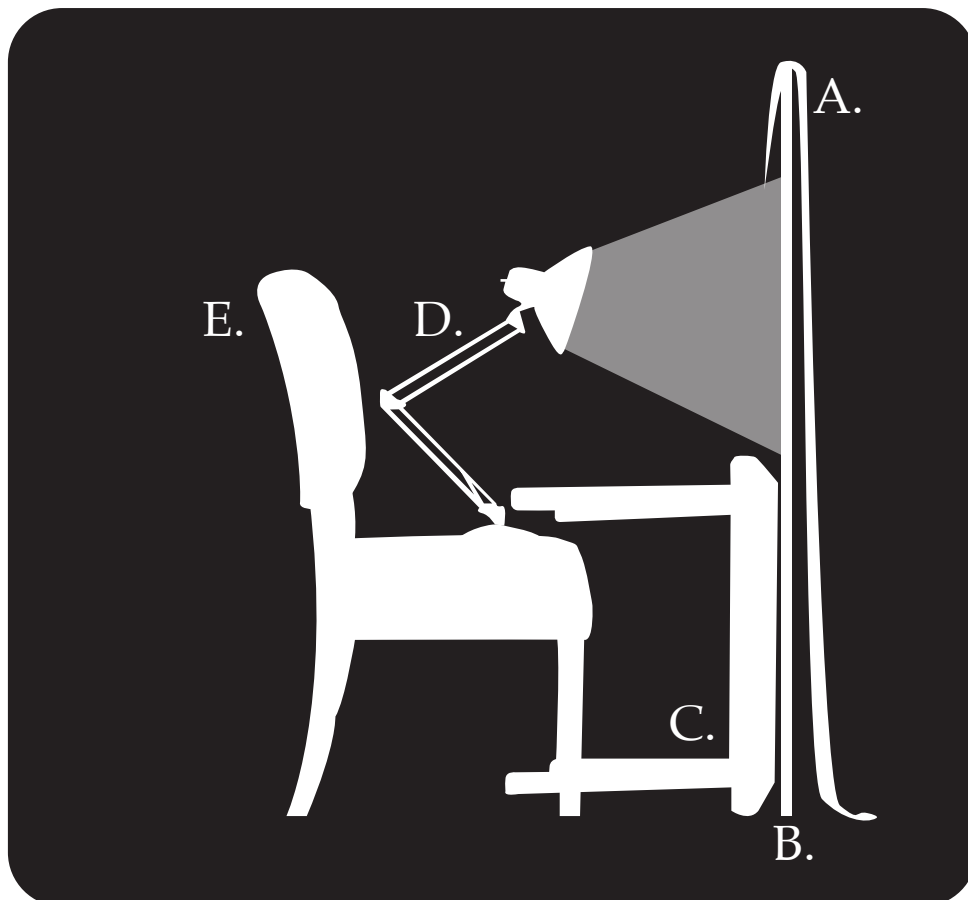

Key

- A. Sheet
- B. Frame
- C. Table on its side
- D. Lamp
- E. Chair

Origami boats

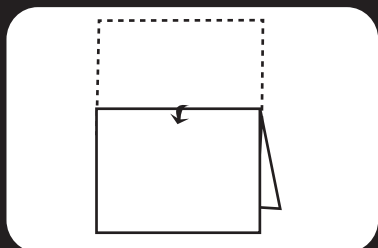

1. Fold an A4 piece of paper in half.

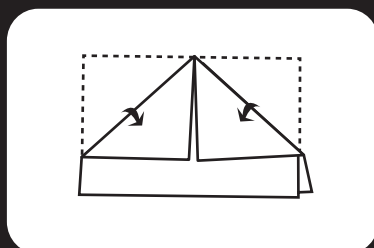

2. Fold the two top corners in to the centre. (You may need to make a crease first.)

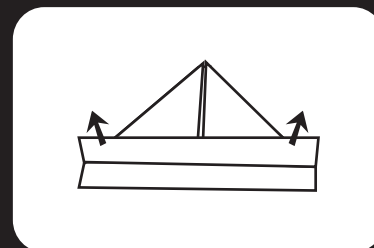

3. Fold up the lower edge of the paper. Turn over and do the same on the other side.

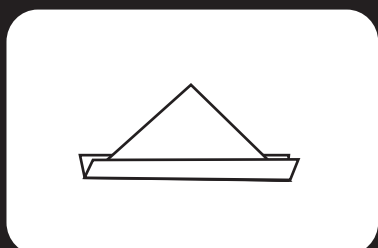

4. Tuck the corners of one of the rectangular sections in behind the triangle.

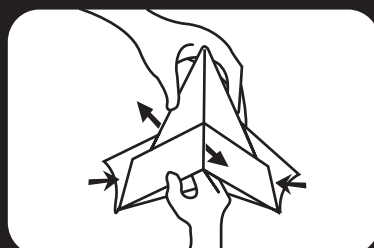

5. Hold the triangle near the top and squash it in, so that it collapses into a square shape.

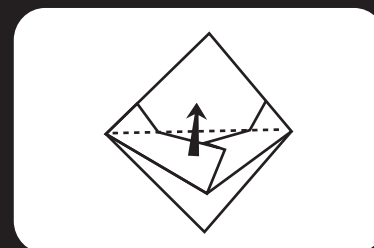

6. Fold up the bottom corner of the square. Turn it over and do the same on the other side.

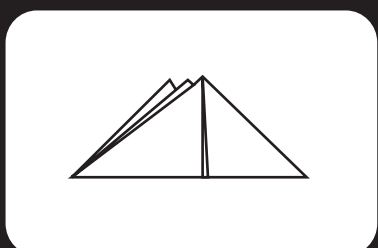

7. You should now have a shape that looks like this.

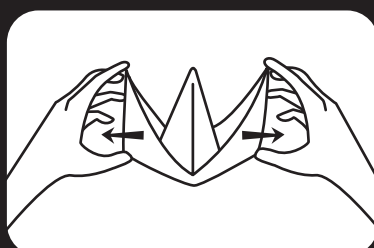

8. Holding the base and the top of the triangle, gently pull the points of the triangle apart and allow the sides to lift up. It should open up into a boat shape that will float on water.

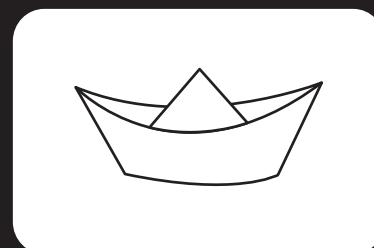

The amazing walk through a card trick

